



# Technical Manual

# POWER DISTRIBUTOR RLC-1050

### Table of Contents

Parts List .....2,3  
Case Outlines.....3  
PCB Assembly .....4-6  
Schematic Diagram .....7-8

**THE ROTEL CO., LTD**

SHINSEN-BLD. 4F 10-10 SHINSEN-CHO, SHIBUYA-KU,  
TOKYO 150-0045, JAPAN

Serial. NO. Beginning
--------------------------

Y-323A-00015C/S-S



# Parts List

SYMBOL	PARTS NO.	DESCRIPTION
	<b>X-1278-01 PCB ASSEMBLY</b>	
C101-104	044 DE1307E472	SPARK KILLER
C105	041 UTWS1V102	CAPACITOR ELEC.35V1000UF
C106-108	041 UTWS1E101-FB	CAPACITOR ELEC.25V100UF
C109	041 UTWS1E470-FB	CAPACITOR ELEC.25V47UF
C110-112	043 TC50V103	CAPACITOR CERA.50V0.01UF
C113	044 50MSAN104J	CAPACITOR FILM 50V0.1UF
C114	041 UTSS1H0R1-FB	CAPACITOR ELEC.50V0.1UF
C115.116	043 TC50V103	CAPACITOR CERA.50V0.01UF
C117	044 50MSAN104J	CAPACITOR FILM 50V0.1UF
C118	041 UTSS1H0R1-FB	CAPACITOR ELEC.50V0.1UF
C119.120	043 TC50V103	CAPACITOR CERA.50V0.01UF
C121	044 50MSAN104J	CAPACITOR FILM 50V0.1UF
C122	041 UTSS1H0R1-FB	CAPACITOR ELEC.50V0.1UF
C123.124	043 TC50V103	CAPACITOR CERA.50V0.01UF
C125	044 50MSAN104J	CAPACITOR FILM 50V0.1UF
C126	041 UTSS1H0R1-FB	CAPACITOR ELEC.50V0.1UF
C127.128	043 TC50V103	CAPACITOR CERA.50V0.01UF
C129	044 50MSAN104J	CAPACITOR FILM 50V0.1UF
C130	041 UTSS1H0R1-FB	CAPACITOR ELEC.50V0.1UF
C131.132	043 TC50V103	CAPACITOR CERA.50V0.01UF
C133	044 50MSAN104J	CAPACITOR FILM 50V0.1UF
C134	041 UTSS1H0R1-FB	CAPACITOR ELEC.50V0.1UF
C135.136	043 TC50V103	CAPACITOR CERA.50V0.01UF
C137	044 50MSAN104J	CAPACITOR FILM 50V0.1UF
C138	041 UTSS1H0R1-FB	CAPACITOR ELEC.50V0.1UF
C139.140	043 TC50V103	CAPACITOR CERA.50V0.01UF
C141	044 50MSAN104J	CAPACITOR FILM 50V0.1UF
C142	041 UTSS1H0R1-FB	CAPACITOR ELEC.50V0.1UF
C143.144	043 TC50V103	CAPACITOR CERA.50V0.01UF
C145	044 50MSAN104J	CAPACITOR FILM 50V0.1UF
C146	041 UTSS1H0R1-FB	CAPACITOR ELEC.50V0.1UF
C147.148	043 TC50V103	CAPACITOR CERA.50V0.01UF
C149	044 50MSAN104J	CAPACITOR FILM 50V0.1UF
C150	041 UTSS1H0R1-FB	CAPACITOR ELEC.50V0.1UF
C151.152	043 TC50V103	CAPACITOR CERA.50V0.01UF
C153	044 50MSAN104J	CAPACITOR FILM 50V0.1UF
C154	041 UTSS1H0R1-FB	CAPACITOR ELEC.50V0.1UF
C155.156	043 TC50V103	CAPACITOR CERA.50V0.01UF
C157	044 50MSAN104J	CAPACITOR FILM 50V0.1UF
C158	041 UTSS1H0R1-FB	CAPACITOR ELEC.50V0.1UF
D101	034 RS403L	BRIDGED DIODE
D102-142	034 T1N4148-86	DIODE
F101	036 5ST500	MINI FUSE 250VT500MA
IC101-103	031 NJM7812FA	IC
IC104.105	031 PC817B	IC
IC106-130	031 NJM555D	IC
L101.102	021 LF143A00	LINE FILTER COIL
Q101	032 TA608-FG	TRANSISTOR
Q102-126	032 TC536-FG	TRANSISTOR
R101	054 1WS1KJF	RESISTOR METAL 1W 1K
R102	053 CR14-393J-A	RESISTOR CARBON 39K
R103	053 CR14-103J-A	RESISTOR CARBON 10K
R104	053 CR14-102J-A	RESISTOR CARBON 1K
R105	053 CR14-393J-A	RESISTOR CARBON 39K
R106	053 CR14-474J-A	RESISTOR CARBON 470K

SYMBOL	PARTS NO.	DESCRIPTION
R107	053 CR14-105J-A	RESISTOR CARBON 1M
R108	053 CR14-103J-A	RESISTOR CARBON 10K
R109	053 CR14-474J-A	RESISTOR CARBON 470K
R110	053 CR14-224J-A	RESISTOR CARBON 220K
R111	053 CR14-474J-A	RESISTOR CARBON 470K
R112	053 CR14-103J-A	RESISTOR CARBON 10K
R113	053 CR14-474J-A	RESISTOR CARBON 470K
R114	053 CR14-224J-A	RESISTOR CARBON 220K
R115	053 CR14-474J-A	RESISTOR CARBON 470K
R116	053 CR14-103J-A	RESISTOR CARBON 10K
R117	053 CR14-474J-A	RESISTOR CARBON 470K
R118	053 CR14-224J-A	RESISTOR CARBON 220K
R119	053 CR14-474J-A	RESISTOR CARBON 470K
R120	053 CR14-103J-A	RESISTOR CARBON 10K
R121	053 CR14-474J-A	RESISTOR CARBON 470K
R122	053 CR14-224J-A	RESISTOR CARBON 220K
R123	053 CR14-474J-A	RESISTOR CARBON 470K
R124	053 CR14-103J-A	RESISTOR CARBON 10K
R125	053 CR14-474J-A	RESISTOR CARBON 470K
R126	053 CR14-224J-A	RESISTOR CARBON 220K
R127	053 CR14-474J-A	RESISTOR CARBON 470K
R128	053 CR14-103J-A	RESISTOR CARBON 10K
R129	053 CR14-474J-A	RESISTOR CARBON 470K
R130	053 CR14-224J-A	RESISTOR CARBON 220K
R131	053 CR14-474J-A	RESISTOR CARBON 470K
R132	053 CR14-103J-A	RESISTOR CARBON 10K
R133	053 CR14-474J-A	RESISTOR CARBON 470K
R134	053 CR14-224J-A	RESISTOR CARBON 220K
R135	053 CR14-474J-A	RESISTOR CARBON 470K
R136	053 CR14-103J-A	RESISTOR CARBON 10K
R137	053 CR14-474J-A	RESISTOR CARBON 470K
R138	053 CR14-224J-A	RESISTOR CARBON 220K
R139	053 CR14-474J-A	RESISTOR CARBON 470K
R140	053 CR14-103J-A	RESISTOR CARBON 10K
R141	053 CR14-474J-A	RESISTOR CARBON 470K
R142	053 CR14-224J-A	RESISTOR CARBON 220K
R143	053 CR14-474J-A	RESISTOR CARBON 470K
R144	053 CR14-103J-A	RESISTOR CARBON 10K
R145	053 CR14-474J-A	RESISTOR CARBON 470K
R146	053 CR14-224J-A	RESISTOR CARBON 220K
R147	053 CR14-474J-A	RESISTOR CARBON 470K
R148	053 CR14-103J-A	RESISTOR CARBON 10K
R149	053 CR14-474J-A	RESISTOR CARBON 470K
R150	053 CR14-224J-A	RESISTOR CARBON 220K
R151	053 CR14-474J-A	RESISTOR CARBON 470K
R152	053 CR14-103J-A	RESISTOR CARBON 10K
R153	053 CR14-474J-A	RESISTOR CARBON 470K
R154	053 CR14-224J-A	RESISTOR CARBON 220K
R155	053 CR14-474J-A	RESISTOR CARBON 470K
RY101	063 V23106-12	RELAY
RY102-113	063 DH1PU-12	RELAY
T101	022 T-1067N01	POWER TRANSFORMER
TH101	034 TNR12G431K	CERAMIC VARISTOR
TH102-125	034 SCK2R512	THERMISTOR
	017 4TR-2792#2	HEAT SINKER BOARD

## Parts List

SYMBOL	PARTS NO.	DESCRIPTION	SYMBOL	PARTS NO.	DESCRIPTION
	019 TO-220	INSULATION SHEET		<b>OTHERS</b>	
	069 C-3417A	FUSE CLIP		011 FP-505	FRONT PANEL ASSY
	<b>X-1278-02 PCB ASSEMBLY</b>			012 SD4-16A00	PUSH BUTTON
C201	041 UTSS1C221-FB	CAPACITOR ELEC.16V220UF		014 QM4-19A00	ROUND BAR
				014 QM4-20A00	ORNAMENT WASHER
				014 1TQF-5	BOTTOM BOARD
D201	034 1N4004	DIODE		018 QM3-14A00	PRINTED CHASSIS BODY
R201	053 CR14-102J-A	RESISTOR CARBON 1K		019 QM3-10A00	AC OUTLET COVER
R202	054 1WS39KJF	RESISTOR METAL 1W 39K		019 4TR-2807	PLASTIC FOOT CAP
S201	061 C-4176A08	POWER SWITCH		063 A-0710W-16A	BREAKER
				069 C-4637A00	AC INLET(MAIN)
	<b>X-1278-03 PCB ASSEMBLY</b>			069 C-4626A00	VOLTAGE SELECTOR
J1	065 YKB21-5103J	MINI JACK		069 C-4656A02	AC INLET(CONTROL)
				069 C-4664A00	AC OUTLET ASSY
	<b>X-1278-04 PCB ASSEMBLY</b>			072 C-4392A02	AC CORD SET for STD
K1	067 C-4635A02	2P TERMINAL BLOCK		072 C-4393A03	AC CORD SET for CEE
				072 C-4423A03	AC CORD SET for AUSTRALIA
	<b>E-1279 PCB ASSEMBLY</b>			072 C-4639A01	AC CORD SET for UK
C301-324	041 UTSS1E330-FB	CAPACITOR ELEC.25V33UF		081 QM4-16A0	INSIDE CARTON
D301-312	034 LTL4262N	LED		081 TZ-158	SIDE STYROL MOULDING
D313-324	034 T1N4148-86	DIODE			
R301-324	053 CR14-154J-A	RESISTOR CARBON 150K			
R325-336	053 CR14-392J-A	RESISTOR CARBON 3.9K			
VR301-324	051 C-4170A29	VARIABLE RESISTOR 1MB			
	019 4TR-3213	LED HOLDER			

**NOTE ON SAFTY :** Symbol  Fire or electrical shock hazard. Only original parts should be used to replaced any part marked with symbol  . Any other component substitution (other than original type), may increase risk of fire or electrical shock hazard.

## Case Outline

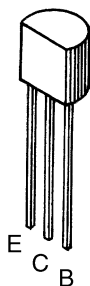

2SA608K  
2SC536K

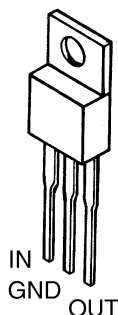

NJM7812

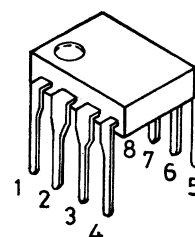

NJM555D

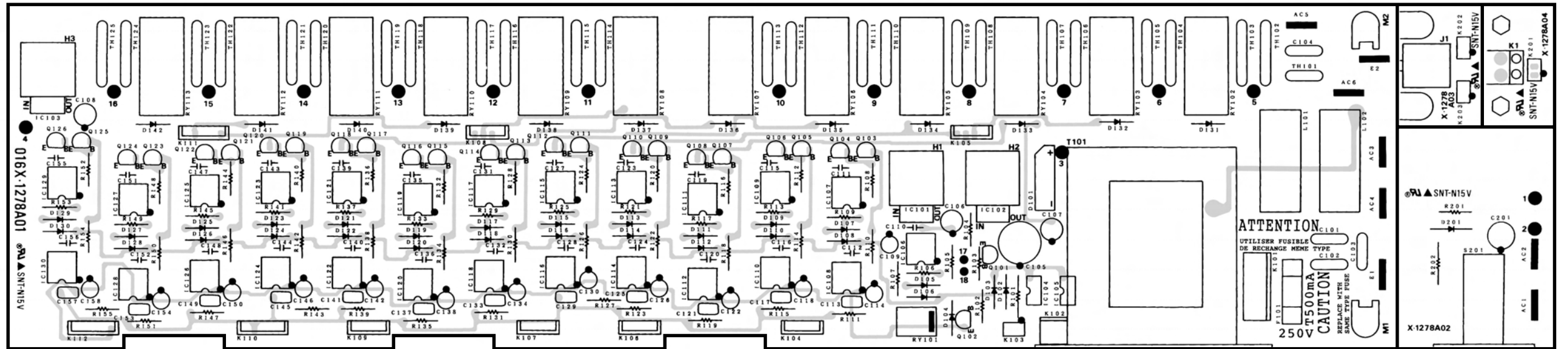
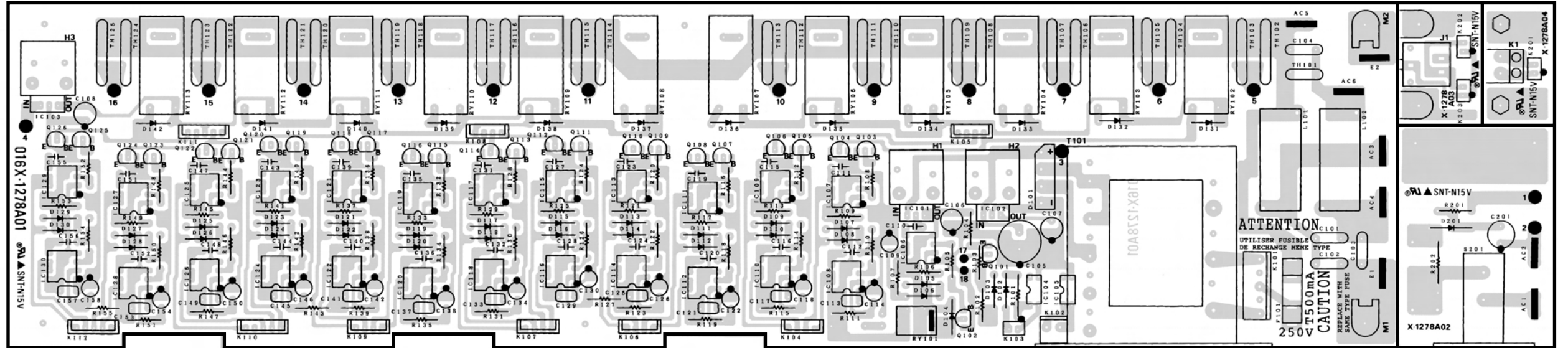
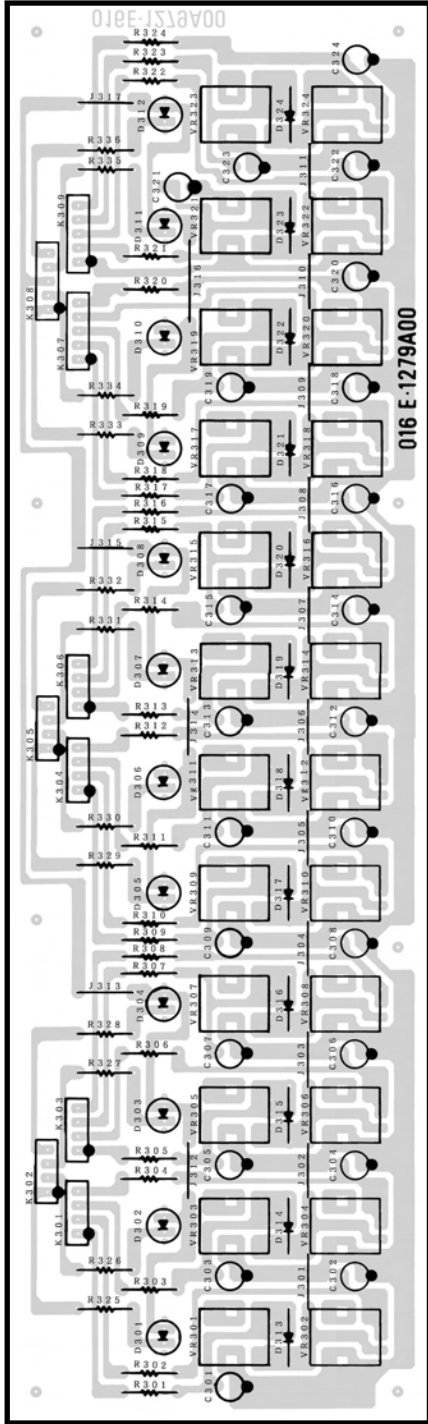

# Schematic Diagram

